



thermoscreens®

DESIGNER C RANGE AIR CURTAINS

Horizontal and Vertical

INSTALLATION, OPERATION & MAINTENANCE INSTRUCTIONS



PLEASE READ THESE INSTRUCTIONS CAREFULLY BEFORE ATTEMPTING INSTALLATION

Thermoscreens Ltd
St. Mary's Road Nuneaton
Warwickshire England
CV11 5AU

Email: sales@thermoscreens.com

Tel: +44 (0) 24 7638 4646

Fax: +44 (0) 24 7638 8578

www.thermoscreens.com



UN-PACKING YOUR DESIGNER AIR CURTAIN

The following items are supplied and packaged within the boxes.

■ Designer Air Curtain

Horizontal or Vertical Designer Air Curtain
plus fittings

■ Remote Control



■ Motorised Valve (LPHW units only)



■ Accessories

Spare M4 socket button screws
2.5mm hexagon key wrench
M10 stainless steel dome nuts (vertical unit)
M8 stainless steel dome nuts (horizontal unit)
Fixing kits (if applicable)
RJ extension lead (vertical unit)

If anything is missing or damaged please contact your place of purchase immediately.

For your records

Date of Purchase.....
Place of Purchase.....
Serial Number.....

**For warranty purposes proof of purchase is necessary so please
keep a copy of your invoice.**

(All documentation supplied with each unit should be stored and kept for future reference).

INSTALLATION OF YOUR HORIZONTAL APPLICATION DESIGNER AIR CURTAIN

The Designer air curtain should be surface mounted inside the doorway and not exposed to the external environment or moist conditions. It should not be built-in or recessed in any way.

■ Location

Ensure that the unit is mounted within its height specification of 1.8m to 2.75m maximum (from floor level to the underside of the unit) with the air discharge grille positioned nearest to the door. The air curtain should be located as close to the door opening as possible for best performance, obstructions such as door opening devices, structural beams etc will reduce the efficiency of the air curtain. There must be at least 200mm clearance at the air inlet for air to enter the unit, see Figure 1. For maximum effectiveness it is essential to ensure the width of the air curtain is slightly wider than the width of the door.

■ Wall Fixing

Using the 2.5mm hexagon key wrench supplied, unfasten and remove casing screws from the Designer unit and carefully detach the back and inlet grille panels. All screws should be kept safe as they will be required later in the installation.

Before fitting the unit to the wall obtain suitable wall fixing bolts, taking into account wall type and unit weight (see table 1)*.

Designer horizontal air curtains are supplied with two stainless steel wall brackets fitted to each end of the unit. Refer to Figure 1 for mounting details. Drill the wall accordingly and secure the unit to the wall above the door. Ensure all fixings are correctly fitted and tightened.

Back and inlet grille panels should only be fitted after all functional tests have been completed and verified (See Commissioning).

For multiple air curtains joined together over a doorway a wall bracket must be fitted at each joining point.

* It is the sole responsibility of the installer to ensure that all the fixing points and bolts used are suitable for the air curtain.

Attention: For stainless steel units the inlet grille and back panels are coated in an easy to peel protective film. Please ensure all the protective film is removed before the air curtain is put into service. For clarity, all photographs in the instructions show the stainless steel sheet with the protective film already removed.

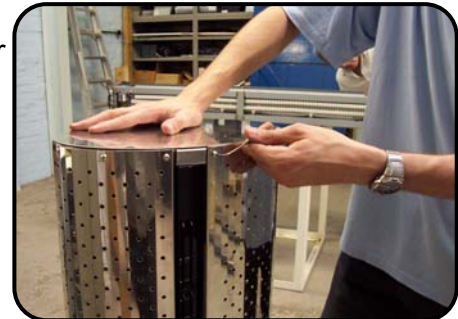

HORIZONTAL DESIGNER AIR CURTAIN

Figure 1

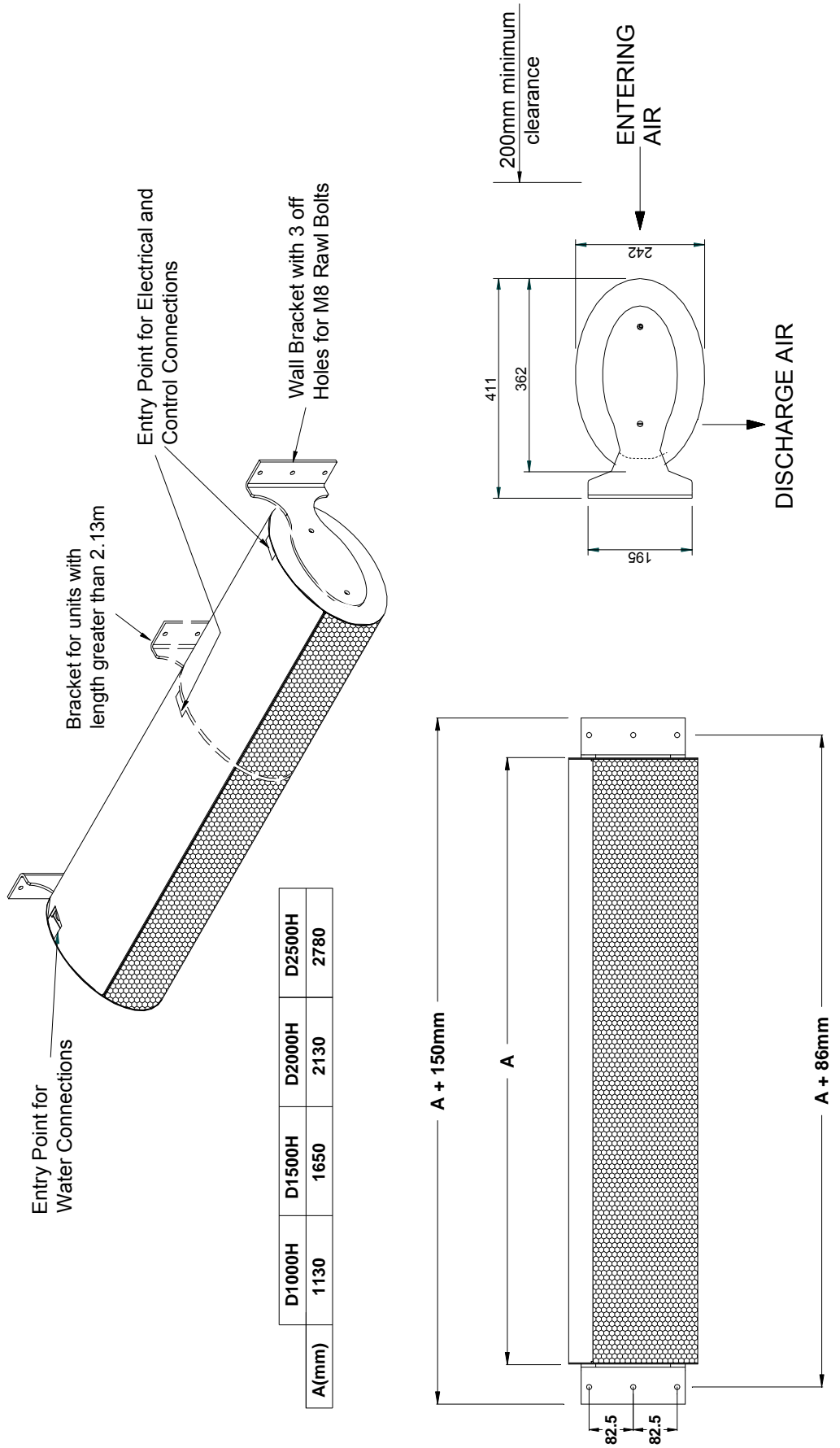

INSTALLATION OF YOUR VERTICAL APPLICATION DESIGNER AIR CURTAIN

The Designer air curtain should be surface mounted inside the doorway and not exposed to the external environment or moist conditions. It should not be built-in or recessed in any way. Do not install a vertical Designer air curtain in a doorway situation where there is likelihood, or there has been a history of, rain ingress.

■ Location

Prior to commencing any vertical installation it is essential to ensure the correct handing Designer unit(s) have been selected.

The air curtain is located close to the door opening with the base plate touching the wall (see photo below) and with the air discharge grille positioned nearest to the door (see "Handing Guide" in Figure 2). Maximum doorway width = 1.5m per air curtain. For maximum effectiveness it is essential to ensure the height of the air curtain is slightly higher than the opening height of the door. Obstructions such as door opening devices, structural beams etc will reduce the efficiency of the air curtain. There must be at least 200mm clearance at the air inlet for air to enter the unit, see Figure 2.

■ Floor Fixing

Using the 2.5mm hexagon key wrench supplied, unfasten and remove casing screws from the Designer unit and carefully detach the back and inlet grille panels. All screws should be kept safe as they will be required later in the installation.

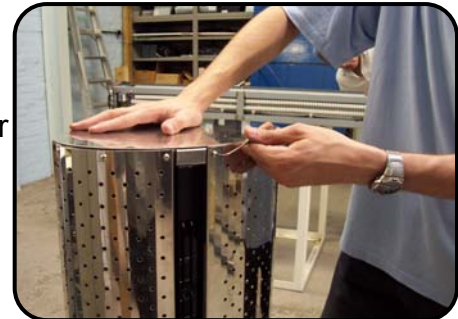

Before installing the Designer unit obtain four suitable fixing bolts, taking into account floor type and unit weight (see table 1)*. Rawlplug[®] M10 Projecting Rawlbolt[®] 44356 type may be suitable. For dimensional details refer to the general assembly drawing, Figure 2.

Designer vertical air curtains are supplied with the base plate fitted. Determine and place the unit at its most favourable position. A wall bracket must be fitted to the top of the unit for D2000 and D2500 air curtains to tether the top of the unit to the wall. In order to use the wall bracket supplied ensure the back of the base plate touches against the wall.

Using the base plate as a template, mark the location of the four holes, as indicated in the adjacent picture.

Using a suitable masonry drill bit correctly drill the four marked out holes. Place M10 fixing bolts into each hole, ensuring all bolts are upright.



Reposition the air curtain base plate over the projecting bolts. Tighten each M10 nut as indicated in the adjacent picture. Ensure the vertical unit is secure, level and square.



Using a hacksaw carefully cut the projecting bolt flush with the nut, ensuring the base plate is not damaged or marked in any way.



Remove only one M10 nut and refit and secure bolt with a stainless steel M10 dome nut supplied. Repeat for each of the other three projecting bolts one at a time.



Back and inlet grille panels should only be fitted after all functional tests have been completed and verified (See Commissioning).

■ Stacking Air Curtains

Only a single 1.0m stacking vertical air curtain should be mounted on top of another vertical unit. The maximum overall height for stacking is 2.78m (1.5m + 1.0m vertical). All units higher than 1.5m must be secured with a wall bracket at the top of the stack.

Using fixing kit components supplied the vertical stack frames are joined together using M8 x 25mm hexagonal bolts and M8 nyloc nuts (see insert).

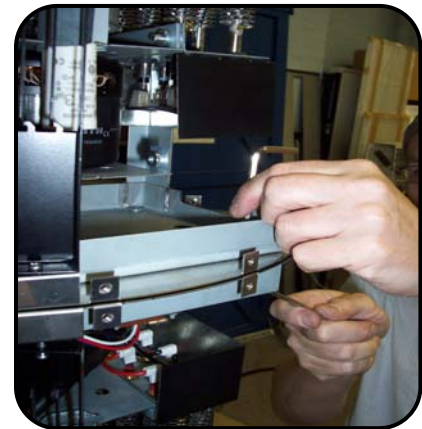

* It is the sole responsibility of the installer to ensure that all the fixing points and bolts used are suitable for the air curtain.

Attention: For stainless steel units the inlet grille and back panels are coated in an easy to peel protective film. Please ensure all the protective film is removed before the air curtain is put into service. For clarity, all photographs in the instructions show the stainless steel sheet with the protective film already removed.

VERTICAL DESIGNER AIR CURTAIN

Figure 2

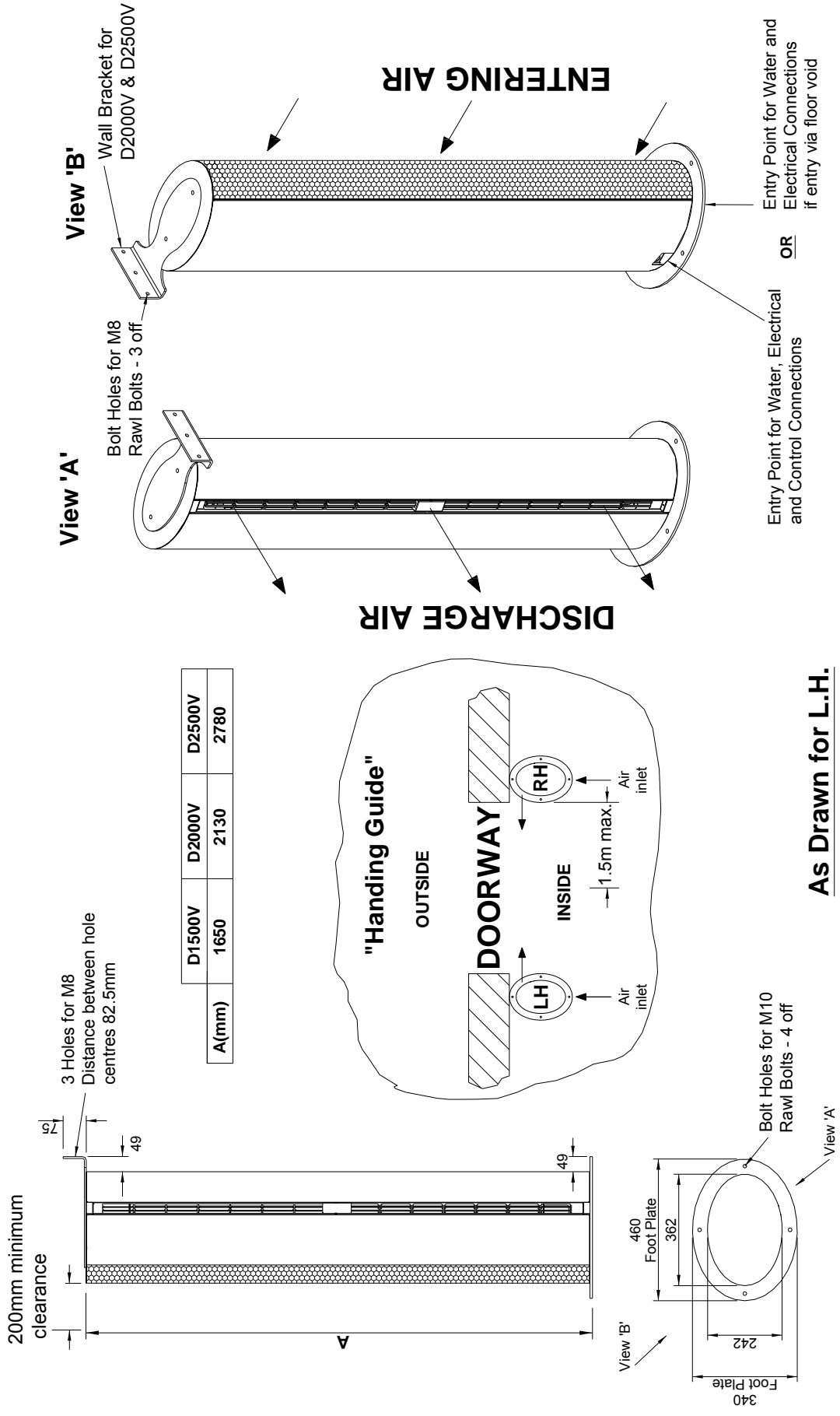

As Drawn for L.H.
Opposite Hand for R.H.

■ Safety and Electrical Connections

All electrical wiring and connections MUST be carried out by a competent qualified electrician in accordance with the latest edition of the IEE wiring regulations and/or local statutory regulations.

- A single phase or 3 local phase isolator with a contact separation of at least 3mm in all poles must be fitted to the supply wiring (the isolator must be fitted in an accessible position).
- The air curtain must be earthed.
- The appliance must be connected by means of wires having an appropriate temperature rating (heat resistant) (electric models only). Electrical connection entry point for horizontal Designer air curtain is from the left hand side of the unit, refer to Figure 1. Figure 2 and the adjacent picture details optional electrical connection entry points for vertical Designer models. Power and control cables for vertical units should be separately threaded up via the cable trunking provided (see insert).
- Ensure that the supply cables, circuit breakers and other electrical installation equipment are correctly sized for the air curtain being installed; see Table 1.
- On a 3 phase electrical supply the unit requires a neutral connection (3N~).
- Cable glands used for the Electrical Input must be rated IP21 or higher.

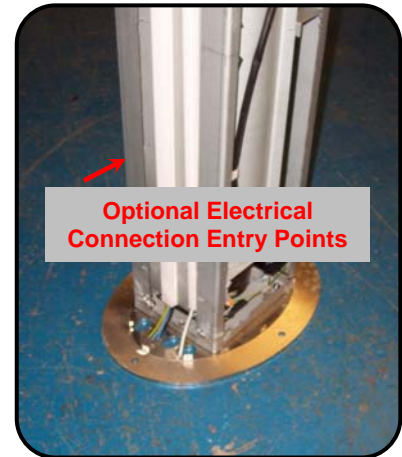
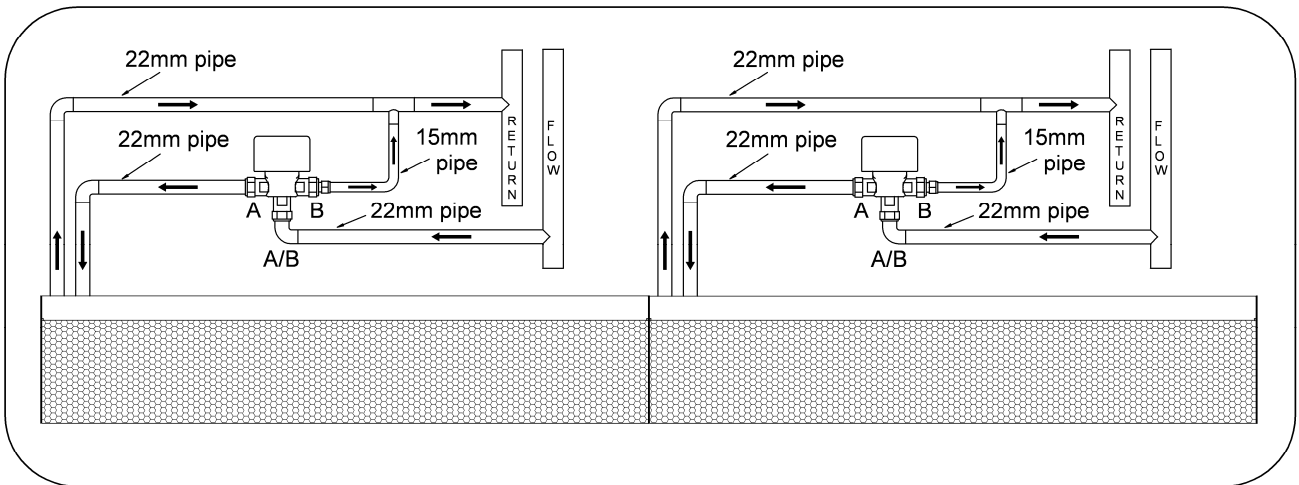

Table 1

Air Curtain	Electrical Supply (V/ph/Hz)	Rated Power Input (kW)	Current per phase (A)	Heat Output (kW)	Weight (kg)
D1000A	230/1/50	0.15	0.7	N/A	30
D1500A	230/1/50	0.20	0.9	N/A	43
D2000A	230/1/50	0.25	1.1	N/A	59
D2500A	230/1/50	0.35	1.6	N/A	73
D1000W	230/1/50	0.15	0.7	6.0	31
D1500W	230/1/50	0.20	0.9	9.0	44
D2000W	230/1/50	0.25	1.1	12.0	60
D2500W	230/1/50	0.35	1.6	15.0	75
D1000E	400/3/50	9.15	13.7	4.5/9.0	32
D1500E	400/3/50	12.20	18.3	6.0/12.0	45
D2000E	400/3/50	18.25	27.2	9.0/18.0	62
D2500E	400/3/50	21.35	32.0	10.5/21.0	77

■ LPHW Models

For LPHW models ensure suitable water mains isolation valves are fitted in the flow and return pipework. When fitting the 3-port valve ensure that the pipe connections are fitted as detailed below and are in accordance with the manufacturers leaflet supplied with the valve.



Designer vertical LPHW stacked units will be supplied with a suitable pipe connecting kit and balancing valves to ensure heat output is even over the whole height of the air curtain.

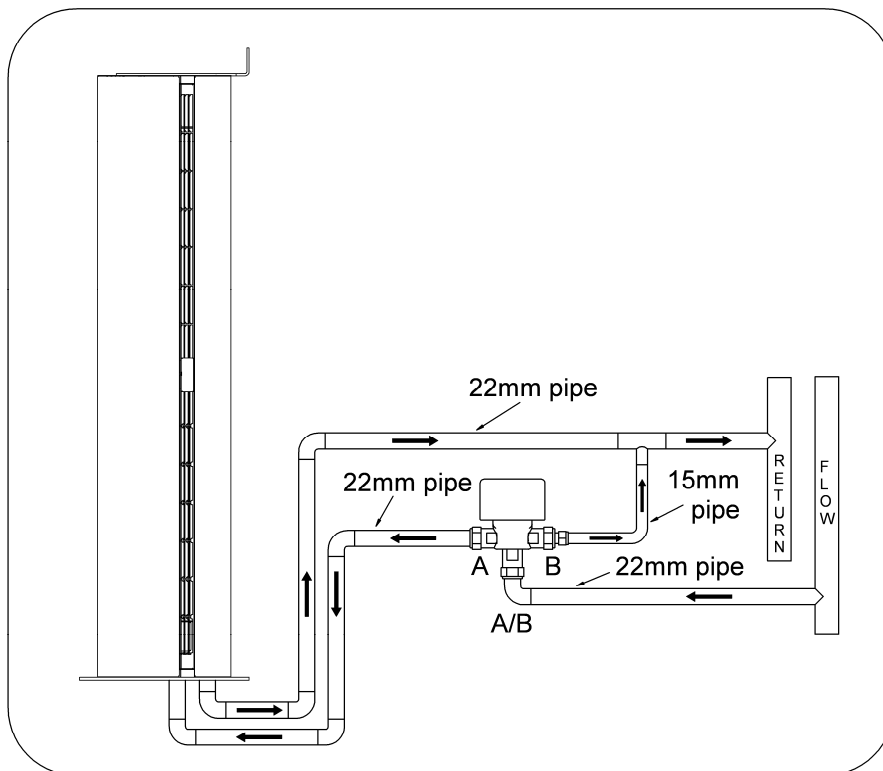

Air Curtain	Water Flow Rate (l/s) 82/72 °C	Coil Water Pressure Drop (kPa)
D1000W	0.14	2.77
D1500W	0.21	6.74
D2000W	0.29	13.40
D2500W	0.35	15.20

■ Fitting/Connecting the Remote Control

The Ecopower Plus controller uses extra low voltage to communicate via the RJ control cable supplied. The controller should be located in a suitable place for easy access, it can be fixed to the wall via various fixing slots provided in the back case or onto an electrical switch box (not provided). To mount controller onto an existing switch box, feed one end of the control cable through the switch box (see insert).



Using a screwdriver undo screw mounted on the top of the controller case. Pull the front case slightly forwards and lift the back case away.



Feed and secure the RJ control cable through one of the openings in the back case and secure back case to switch box using 2 x M3.5 mounting screws (not provided).



With the cable RJ plug locking clip lying nearest to controller PCB, connect the RJ plug to the RJ socket on the board.

Note: For controller DIP switch options refer to *Ecopower Plus Remote Control Operation and DIP Switch Settings*.



Refit the controller front case to the back case. The air curtain end of the control cable should be connected to one RJ socket fitted either on the top panel for NT or the Ecopower motherboard inside a recessed air curtain. Ensure the control cable is safely secured.

The remote control is supplied with 6m of cable and a pre-fitted connecting plug. Ensure the remote control cable is safely secured and connected. For vertical Designer an extension lead with an in-line connector is supplied for threading the control cable within the unit (see insert).

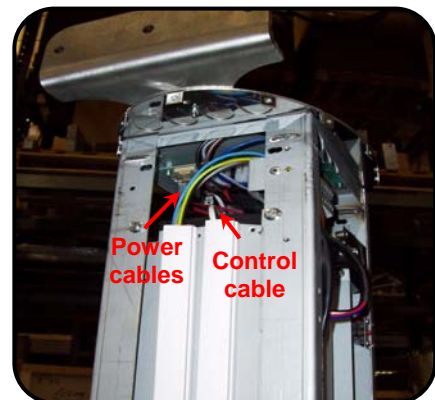

■ Multiple Installation

To Master/Slave two or more air curtains together, or if there are two air curtains in a vertical stack, the remote control is plugged into the first unit (the Master) and a RJ extension lead then connected from the Master to the Slave unit(s).

Horizontal application air curtains, up to a maximum of eight units, may be connected as indicated below. Thermoscreens 3m RJ extension leads are available and should be ordered separately.

For horizontal Master/Slave configuration an independent mains supply as per Table 1 must be supplied to each air curtain.

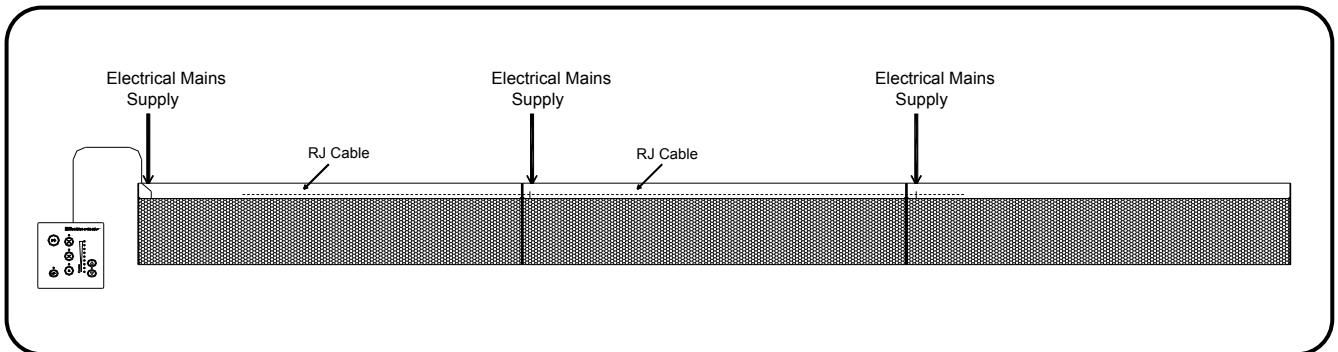

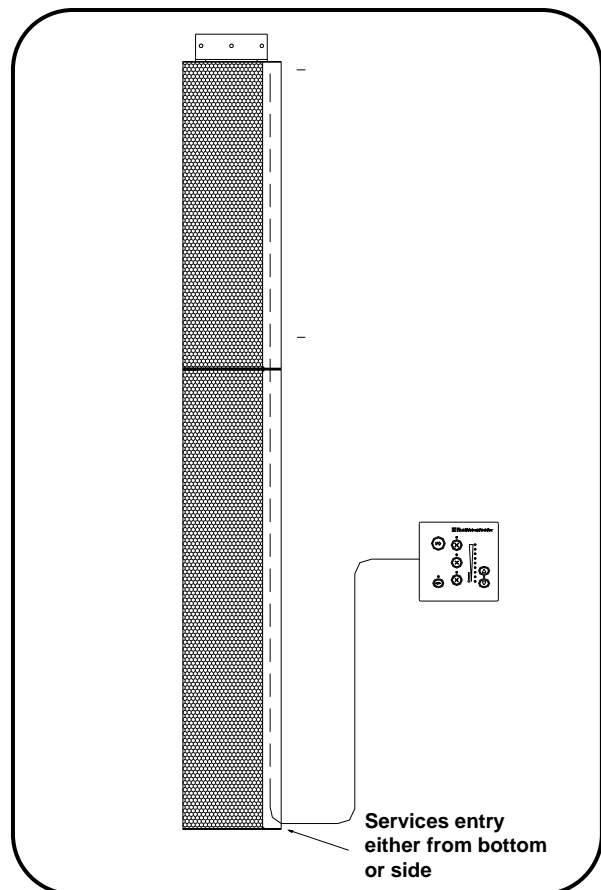

The maximum height for a vertical stack is 2.78m (1.5m + 1.0m vertical). An RJ extension lead and in-line RJ connector is supplied with vertical stack units.

Ensure all incoming electrical mains supply cables are suitable for the total power rating of the air curtain stack (see D2500).

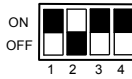

■ Ecopower Controller Motherboard

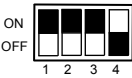
Function	Control	Comments	Standard
Fan Heat Interlock – The heat output is governed by the fan speed. If low or medium fan speed is selected the heat output will operate on only first heat stage. Second stage heating will only operate on high fan speed.	DIP1 Option 	Suitable on vertical electrically heated Designer air curtain. Maximum heat output achieved if maximum fan speed selected. Independently set-up DIP switch on each mother board. This feature operates in manual or auto mode.	As supplied, the default setting would be for heat and fan settings to be independent (DIP1 OFF).
Disable Fan Run-on – Disable fan run-on.	DIP2 Option (LPHW & Ambient only) 	Must only be used for LPHW and Ambient air curtains. Independently set-up DIP switch on each mother board.	As supplied, the default setting would enable fan run-on (DIP2 OFF).
Thermostat Master – Only the air sensor thermistor in the master air curtain will be used for measuring the reference air temperature for the whole master/slave installation.	DIP3 Option 	The air sensor thermistors in all the slave air curtains will be ignored. This will then avoid situations on larger doorways with master/slave air curtains where some units can blow cold air whilst others can blow warm air, because they currently all refer to their own air sensor for control of the heat output of each air curtain. The master air curtain need not be the one that the wall control is plugged into. This dip switch setting must also be used for Global Switching (Master/Slave) via the INHIBIT terminal – see next page.	As supplied, the default setting would be for the air sensor thermistor on all units to be measuring (DIP3 OFF).
Overheat Fan Disable – If DIP4 is on and thermal cut-out(s) operate both heat and fan circuits are isolated and LED's on wall switch flash. If DIP4 is off and thermal cut-out(s) operate, only the heating circuit is isolated and the LED's on the wall switch flash.	DIP4 Option (Electric only) 	Independently set-up DIP switch on each mother board. <i>To remove fault, isolate electrical supply to air curtain, reset TOC and reconnect supply.</i>	As supplied, the default setting would enable fan if TOC trips (DIP4 OFF).
Fan run-on time set two minutes.	Built-in	If "FAN ONLY" has been selected, at switch off, no fan run-on.	

□ - white rectangle indicates the moveable head of each 4 way DIP switch

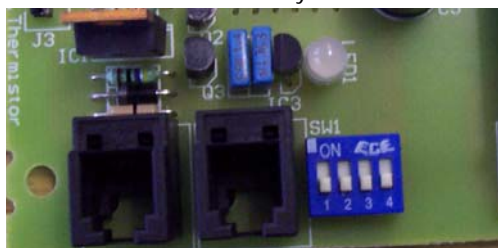

DIP switches fitted on the Ecopower board provide a selection of optional features as described above. Isolate and switch electrical power off before configuring and/or changing any DIP switch settings.

- Easy plug-in arrangement for remote air sensor thermistor on a 1m lead. Plugging-in the remote air sensor to **J3** disables the standard air sensor thermistor already fitted on the Ecopower board. As supplied, the board will not have the remote air sensor fitted.

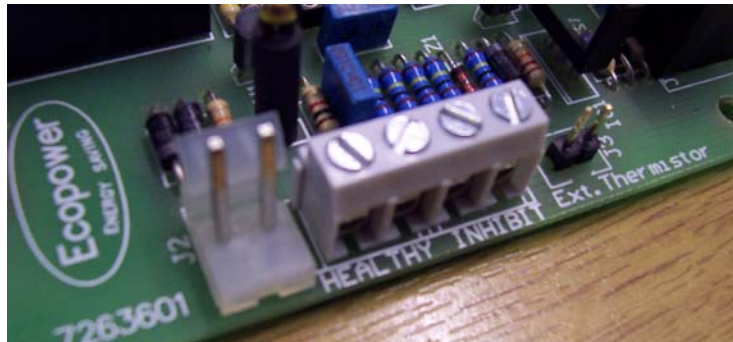

- An **INHIBIT** two screw terminal fitted on the Ecopower board for BMS remote On/Off feature. If the terminal is linked, i.e. by 2 wires to a remote volt free contact, the unit will run. If it is open circuit across the terminal the unit will switch off. This remote On/Off feature has global switching logic, i.e. if you master/slave several units together you need connect the remote contact to only one of them to turn all units on and off in the master/slave system. For global switching to work on the slave units, need to set DIP3 Option (see previous page) on the unit that the remote contact is wired to and have previously turned the unit on with the wall switch. As supplied, a wire link will be fitted to the terminal block on every unit. For summer settings place a 3.3k Ω resistance across the **INHIBIT** terminal, with these settings fans only will run even if controller is requesting for heat.

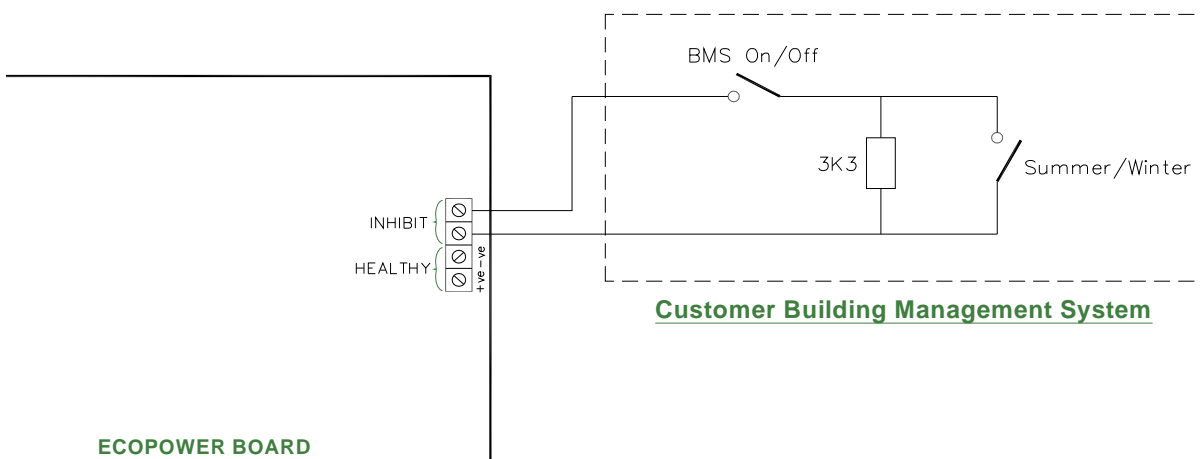

- A **HEALTHY** two screw terminal is included on the board for a fault signal indication if the electric elements overheat cut-out has operated. A healthy system provides a 24V DC signal at the terminals compared to an overheat fault which provides 0V DC.

Wires/cables from pre-wired top vertical stack unit
(ensure all cables are suitable for the total power
rating of the air curtain stack)

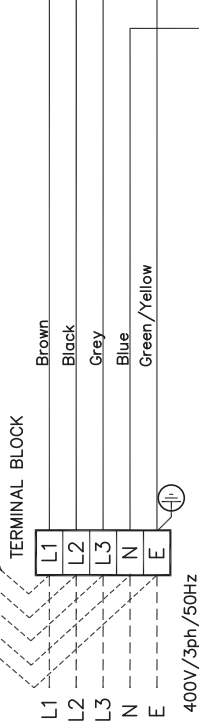

To Slave
Air Curtain

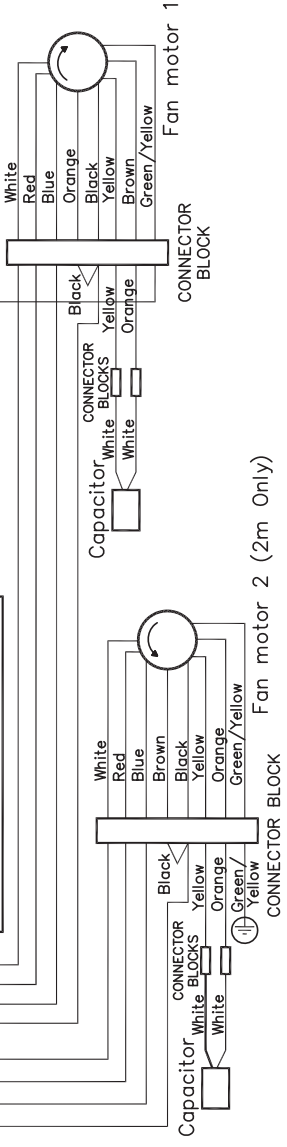
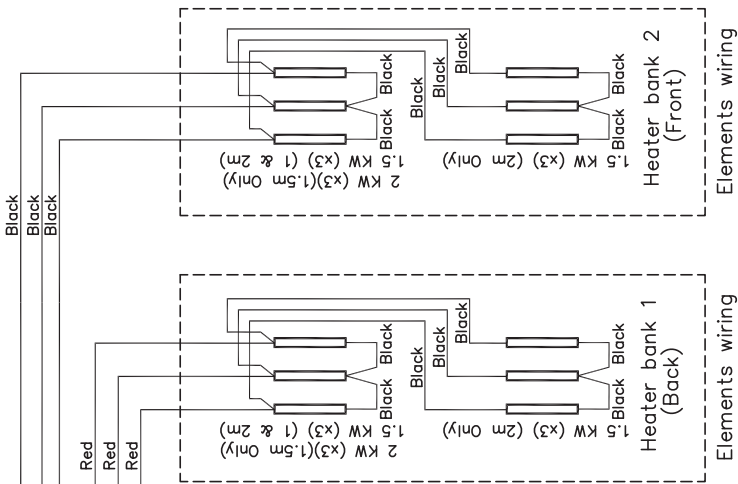
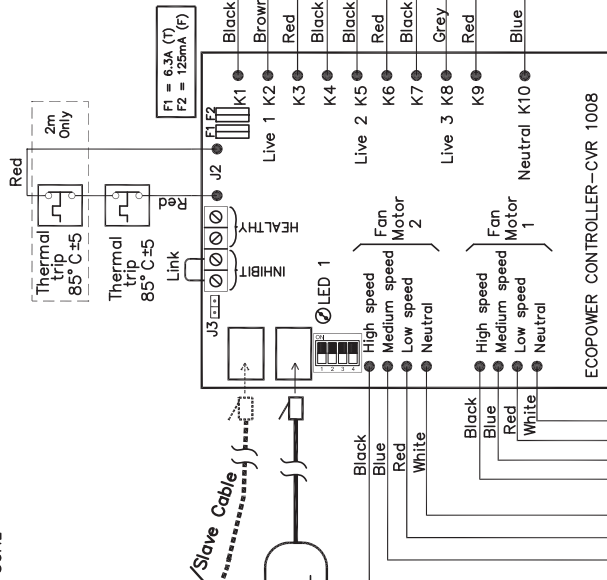

Single Shaft Motor	
7551201	CE2E6694K (1m) — 3µF
7551201	CE2E6694K (1.5m) — 4µF
7551201	CE2E6694K (2m) — 3µF (x2)

D1000E, D1500E, D2000E, D1500E V AND D2000E V

Wires/cables from pre-wired top vertical stack unit
(ensure all cables are suitable for the total power
rating of the air curtain stack)

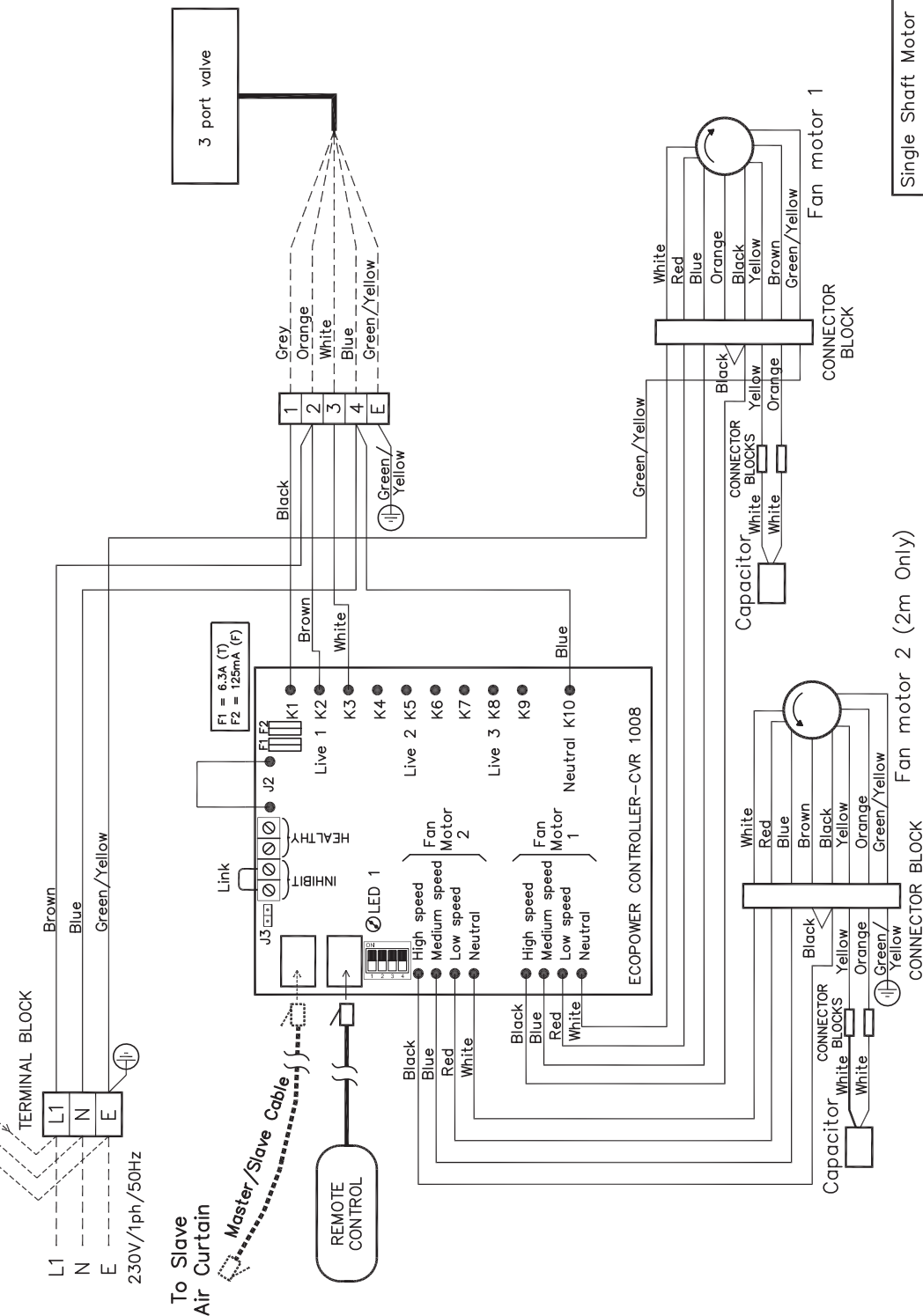

Single Shaft Motor	
7551201	CE2E6694K (1m) – 3µF
7551201	CE2E6694K (1.5m) – 4µF
7551201	CE2E6694K (2m) – 3µF (x2)

D1000W, D1500W, D2000W, D1500W V AND D2000W V

Wires/cables from pre-wired top vertical stack unit
(ensure all cables are suitable for the total power
rating of the air curtain stack)

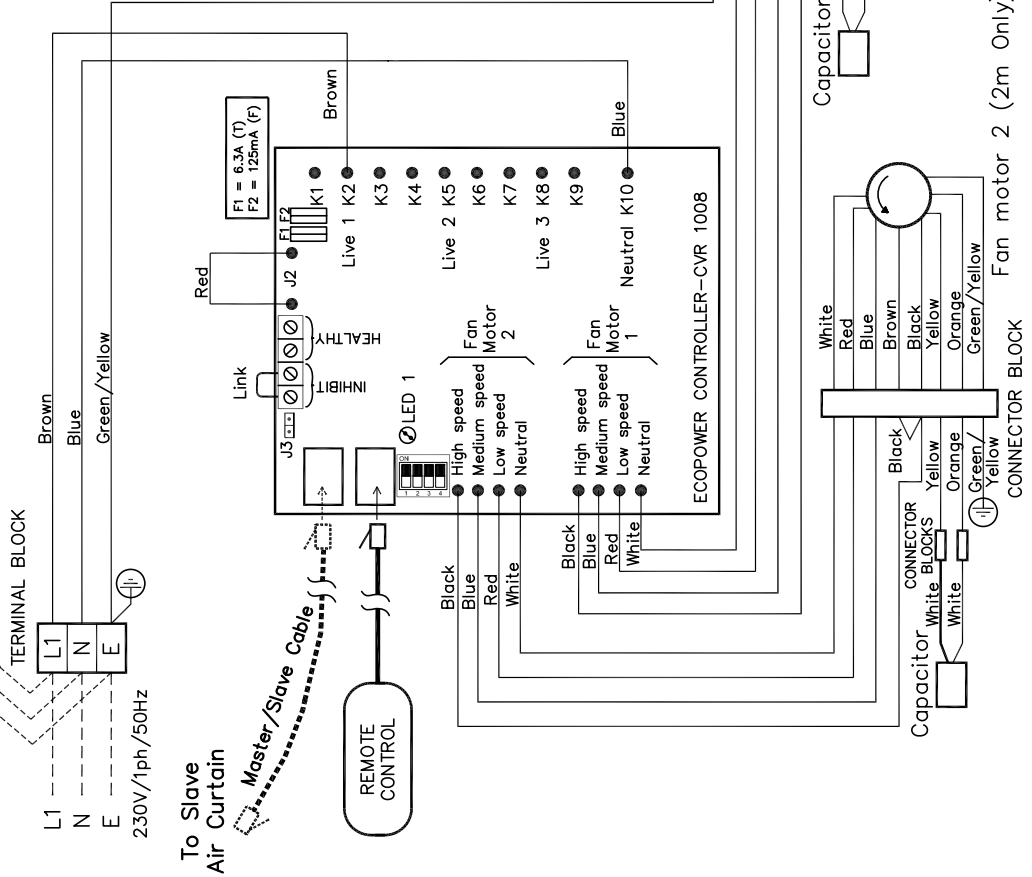

Single Shaft Motor	
7551201	CE2E6694K (1m) – 3µF
7551201	CE2E6694K (1.5m) – 4µF
7551201	CE2E6694K (2m) – 3µF (x2)

D1000A, D1500A, D2000A, D1500A V AND D2000A V

■ Ecopower Plus Remote Control Operation and DIP Switch Settings

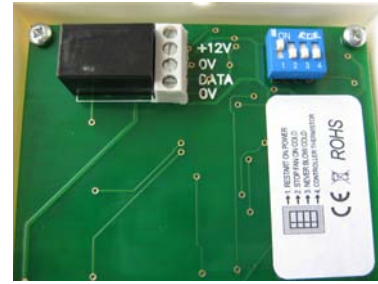
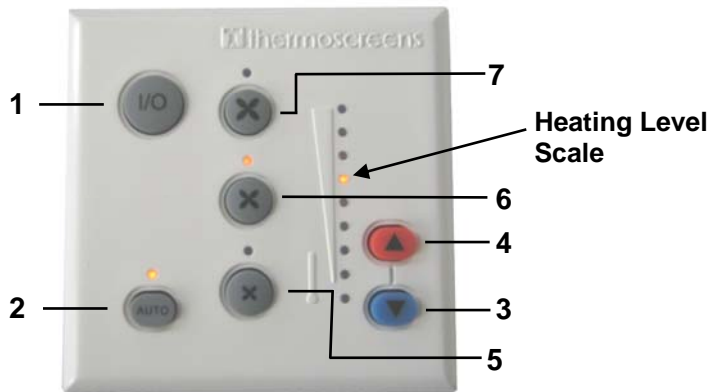

On/Off (I/O)

Press On/Off switch (1) to turn the air curtain On and operate as follows:-

Press Auto switch (2) to cycle between Manual and Automatic modes. The Auto on indicator LED is lit for "Auto Mode" and un-lit for "Manual Mode".

Manual:

Heat output can be selected as Zero, Half Heat or Full Heat. Heating levels are selected by stepping up or down with switches (3) and (4). Heating level indicator LED's go 0%, 50% or 100% to show the level selected.

Automatic:

If DIP switches 1, 2 and 4 on the Ecopower motherboard are set to OFF, the air curtain measures the incoming air temperature and automatically selects the necessary amount of heat to keep it at the level selected.

Fan Speed

Switches (5), (6) and (7) select fan speed low, medium or high respectively. The appropriate LED above each fan speed indicator is illuminated to show which fan speed is selected.

Pressing the On/Off switch (1) again switches the air curtain off with all the LED's switched off. If a heated air curtain is heating when switched off the fan will run-on at low fan speed for an extended time (approx. 2 minutes) to dissipate excess heat.

Do not switch the air curtain On/Off from the isolator. If the mains supply is isolated or cuts-out during operation the safety thermal cut-out(s) for electric heated air curtains within the air curtain may operate. If this happens the thermal cut-out(s) will need to be reset by a competent technician.

DIP Switch Settings

At the back of the Ecopower Plus remote control PCB there are four DIP switches (see above) that provide the following optional features.

DIP1	Restart on Power-Up – If electrical supply to the air curtain is interrupted, upon restoring electrical supply, the customer's settings on the remote control will be retained. The default is with this feature ON.
DIP2	Stop Fan on Cold – Fans switch off when heating level is achieved (Automatic mode only). The default setting is with this feature OFF.
DIP3	Never Blow Cold – Unit always heats in Automatic mode (i.e. will not go to ambient mode). The default setting is with this feature OFF.
DIP4	Air Sensor in Controller – The air sensor in the remote controller is enabled (DIP4 ON) and the air sensor on the Ecopower motherboard in the air curtain is disabled. Temperature control for Automatic Mode is then done at the remote control, which may be an advantage to limit overheating of the door entrance area. The default setting is with this feature OFF.

■ Commissioning

With the casing still removed confirm the air curtain fans operate correctly and there is no excessive mechanical noise coming from the fans. Check that the fans operate at Low, Medium and High speeds, except for Electric Heated Vertical units which only operate at High speed. Use the gate valves to balance heating output evenly across the whole air curtain for D2500V LPHW air curtains that have two heating coils. If the unit is electric heated or water heated check that the air stream from the discharge grille warms up across the whole length of the air curtain when heating is selected. On D2500W water heated stacked units it may be necessary to adjust the balancing valves at the bottom of the air curtain to get even heat output over the whole height of the unit. Check that heating increases as higher heat is selected and feel to see that the warm air stream is reaching across the doorway with door open or closed. Verify the operation of the Ecopower controller in Manual Mode. Then select Auto Mode and increase the heating set point until the air stream warms up. Reduce the heating set point until the air stream goes cold.

Explain to the end user that the doorway should be closed whenever possible but that during times of high pedestrian use it will become effectively 'open doorway'. The air curtain serves an essential purpose by saving energy and providing comfort to the occupants when compared to an open doorway with no air curtain fitted.

Once all functional tests have been carried out and the air curtain operates satisfactorily, firstly hook and locate the back panel around the fixing tabs closest to the outlet grille. Ensure all fixing holes are correctly aligned with tab inserts. Fit and align the two locating pins on the inlet panel with corresponding back panel holes (see insert). Secure both panels using the 26 x M4 socket button screws removed earlier in the installation process.



Before leaving site it is important that the air curtain installation is "Handed-Over" to the end user or his representative and the operation of it is fully explained and that they understand how it operates. Explain also the service intervals and that the unit must be regularly cleaned.

■ Fault Conditions

In the event of a fault the thermal cut out(s) on electric heated units (*Note: If the mains supply is isolated during operation then the thermal cut outs may operate*) or internal fuses may operate. The thermal cut out(s), one on the 1m/1.5m models and two on the 2m model, are located behind the hole marked with a red ring label (see insert).

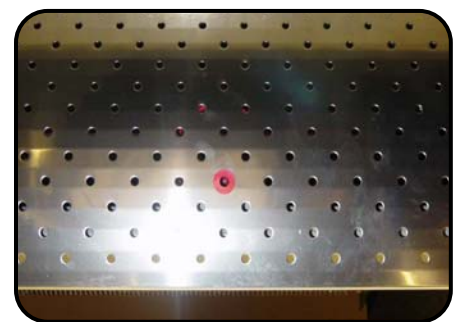

For Ecopower units two internal electrical fuses are located on the Ecopower board; 6.3A (T) supplies the fan motors within the air curtain and 125mA (F) controls the operation of the Ecopower board. If for an electric heated air curtain an overheat fault occurs, or if J2 link is missing for LPHW models, the LED's on the remote control will flash and the Ecopower board status LED on the board will be permanently red to indicate a fault.

In the case of a fault condition (refer to flowchart) do not attempt to reset the thermal cut outs or replace the fuses, arrange for a Thermoscreens appointed technician or certified electrician to attend the unit to investigate the reason why the thermal cut outs/fuse(s) have operated. Once the cause has been determined and rectified, they will reset the thermal cut out and/or replace the fuse and check the operation of the unit.

■ PCB Status

Fitted on the PCB board inside of the air curtain is an LED shown as LED1 on wiring diagrams that will indicate the Ecopower control status.

1. LED flashing green – operation normal.
2. LED flashing red – low supply voltage or controller not plugged into Ecopower motherboard.
3. LED permanently red – thermal cut outs open circuit (electrically heated models) or J2 link missing (LPHW models). Remote Control LED's will also flash to indicate the thermal cut-out(s) has operated or J2 link is missing. Refer to Fault Conditions above detailing how to reset thermal cut-outs.

■ User Fault Finding Flowchart

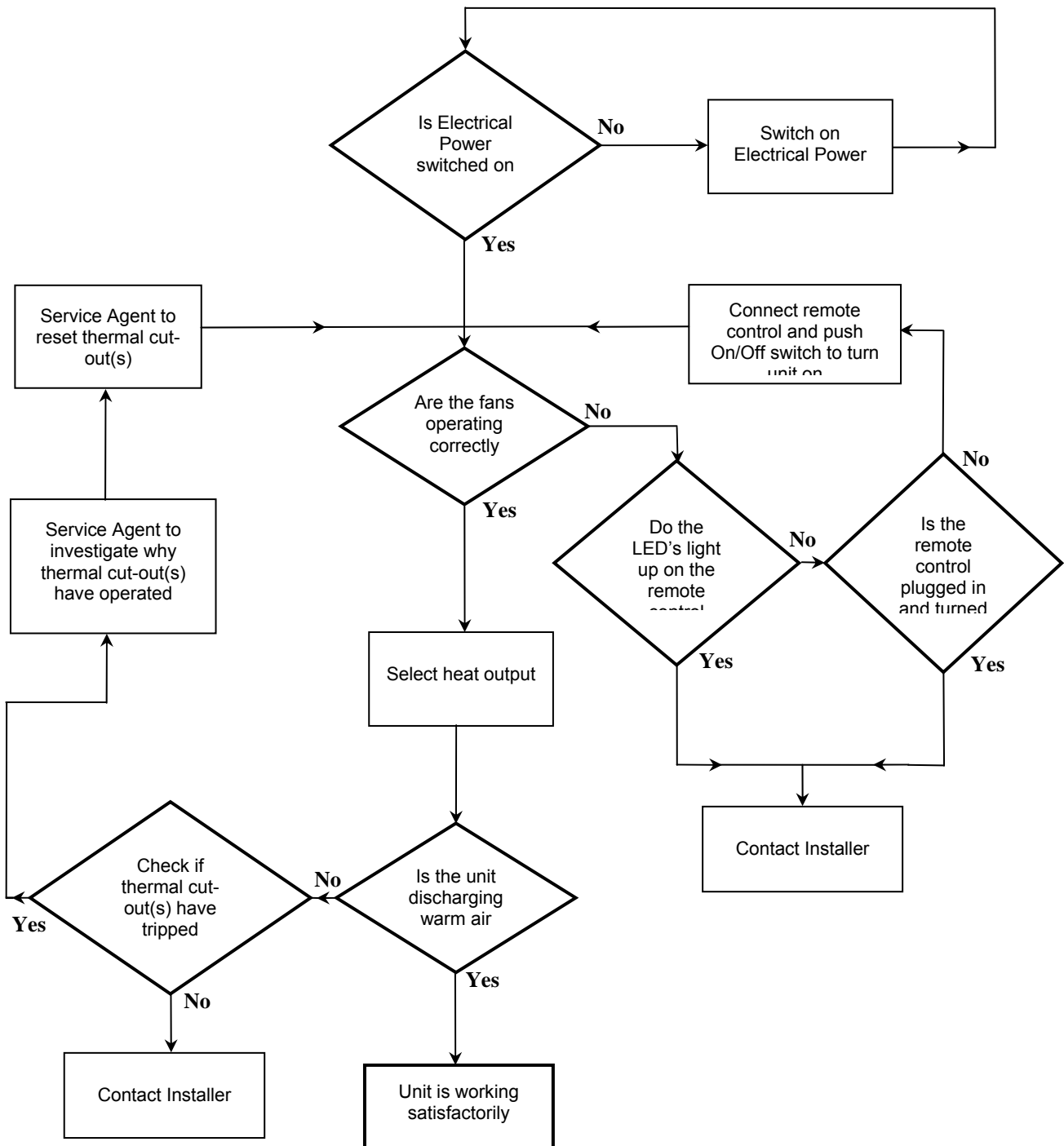

■ Service & Maintenance

Always disconnect and isolate the mains electricity supply before installing, maintaining or repairing this equipment. Note: All maintenance/repairs should only be carried out by a competent electrician or Thermoscreens appointed technician.

To ensure the air curtain operates at full efficiency the back and inlet grille panels, fan impellers, housings and motors must be kept free of dust and debris. Build up of dust on the fan impellers can cause vibration, noise and excessive wear on the motor bearings.

Frequency of cleaning will depend on the environment, but we would recommend that the unit be cleaned a minimum of every 3 months (failure to adequately maintain the unit and provide a suitable cleaning schedule will result in performance degradation and reduce the life expectancy of the air-curtain).

Remove the back and inlet grille panels from the air curtain. Vacuum and clean the build-up of dirt and debris within the air-curtain (*please note that the motor(s) are permanently lubricated and require no additional lubrication*).

Once the air curtain has been cleaned check all electrical connections within the unit ensuring terminals are tight and that crimped connections have not become loose. Re-install the back and inlet panels. Reconnect the electrical supply and fully function test the air-curtain to ensure correct operation (See Commissioning).

■ Warranty

If any problems are encountered, please contact your installer/supplier. Failing this please contact the Thermoscreens warranty department. All units are covered by a two year warranty period.

Care has been taken in compiling these instructions to ensure they are correct, although Thermoscreens disclaims all liability for damage resulting from any inaccuracies and/or deficiencies in this documentation. Thermoscreens retain the right to change the specifications stated in these instructions.

Thermoscreens Ltd
St. Mary's Road Nuneaton
Warwickshire England
CV11 5AU

Email: sales@thermoscreens.com

Tel: + 44 (0) 24 7638 4646

Fax: + 44 (0) 24 7638 8578

www.thermoscreens.com